

# ***MBM 25 Single Spindle Paper Drill***

Instruction Manual



*Provided by*

**MyBinding.com**  
*When Image Matters.*

Call Us at 1-800-944-4573

**UCHIDA**

---

# **VS-15 / VS-25**

---

## **OPERATION MANUAL**

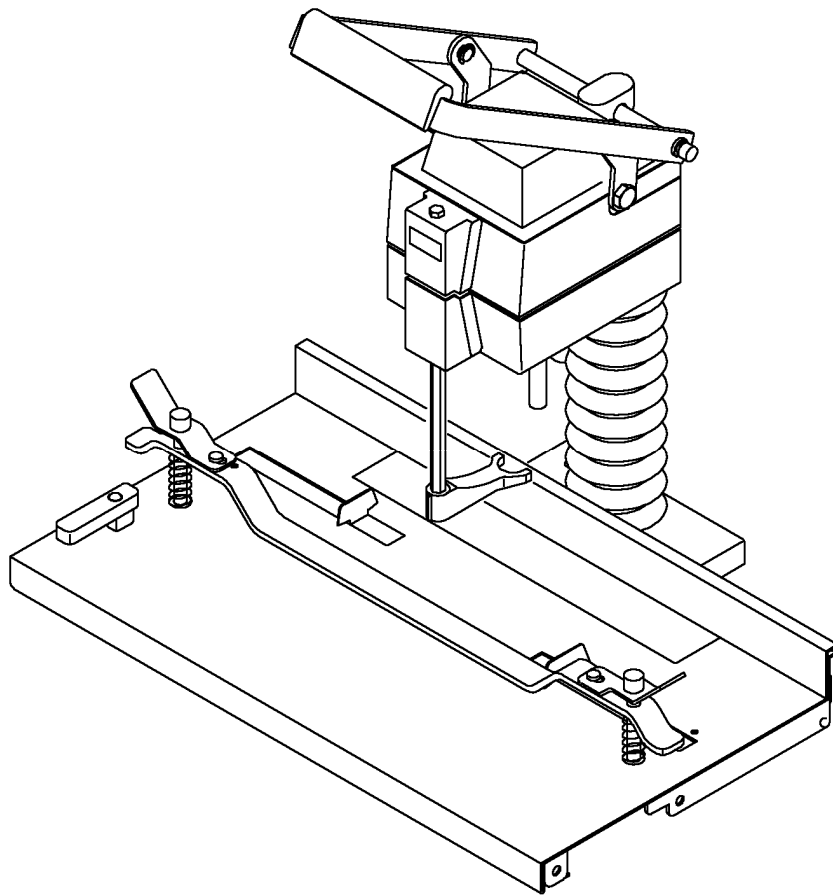

Use the machine properly after reading the "Safety Instructions" given below carefully.

These safety instructions are given to ensure that the machine will be used safely and properly and to prevent operators from sustaining harm and injuries.

MyBinding.com  
5500 NE Moore Court  
Hillsboro, OR 97124  
Toll Free: 1-800-944-4573  
Local: 503-640-5920

V.02

# SAFETY INSTRUCTIONS

## Definition of Symbols and Notes

In this manual following names and signs stand for possible dangers.



### **Danger**

This symbol stands for immediate danger threatening the life and health of persons. Disregarding these instructions may cause severe damage to health and even serious injuries.



### **Caution**

This symbol stands for an endangering situation that may occur. Disregarding these instructions may lead to slight injuries or damage to property.

Explanations of the illustrations used in the Safety Instructions are given as follows:



### **Danger**

1. Don't put a hand under the hollow drill bit. There is a danger of receiving an injury.
2. Don't touch any rotating part. There is a danger of receiving an injury.
3. Don't bring a hand, face, hair, sleeves of clothes and the like close to the rotating parts of the machine. There is a danger of receiving an injury.
4. When you change into unusual states, like smoke comes out, please turn off the power switch of a main part, and pull out a power supply plug from a wall socket after that. There are failure, a fire, and fear of an electric shock.



### **Caution**

1. Please do not install a machine in the unstable place to which it is shaky or leans. There is a danger of receiving an injury.
2. When you move, have a base. There is a danger of receiving an injury.
3. When you install a machine, please install to a place with no dust, and the place which is not influenced with a liquid. It becomes the cause of failure if the installation method is mistaken.
4. Turn off the power supply beforehand when attaching or detaching hollow drill bits. There is a danger of receiving an injury.
5. Don't touch the blade point of the hollow drill bit. There is a danger of receiving an injury.
6. The hollow drill bits become heated when they are drilling. Don't touch them when they are drilling. Touching them may cause a burn.
7. Please do not make a hole in paper with foreign substances, such as a needle of a stapling machine. Moreover, also things other than paper. There is a danger of receiving an injury.
8. Please do not make a hole hard paper and near the hole which have opened in piles. There is a danger of receiving an injury.
9. Turn off the power supply beforehand when adjusting the fiber plug. There is a danger of receiving an injury.
10. When a machine stopped during use, turn off the power switch, and pull out a power supply plug from a wall socket after that. There is a danger of begins to turn again. And there is a danger of receiving an injury.

## Introduction

Read this "Operation Manual" carefully before use. In particular, be sure to read "Safety Instructions" (page 1) to ensure that the machine will be used properly.

Keep the manual at an appointed place with care so that it may be accessible whenever necessary.

The specifications of this product are subject to change for improvement. Therefore, don't mistake the "Operation Manual" of one product of the same model for that of another because descriptions in the "Operation Manual" of products of the same model may differ.

## 1. Before use

---

(1) Check the kinds and quantities of accessories

### Standard Accessories

Hollow drill bit	Normal	6mm X 1pc.
	U.S. version	6.5mm X 1pc.
Hexagonal wrench	4mm X 1pc.	
Fiber plug	2pcs. (W290xD41xH3)	
Chip receptacle	1pc.	
Sharpener	1pc.	
Oilstone	1pc.	
Paraffin	1pc.	
Eyeleteer	1pc.	
Operation manual	1pc.	

MyBinding.com  
5500 NE Moore Court  
Hillsboro, OR 97124  
Toll Free: 1-800-944-4573  
Local: 503-640-5920

(2) Exterior features

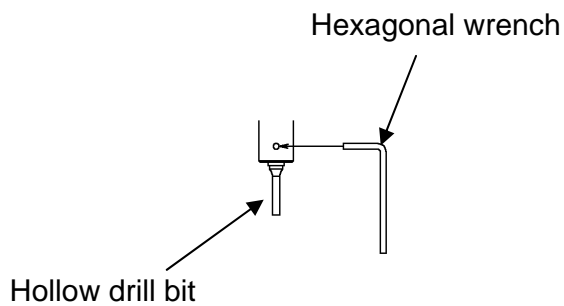
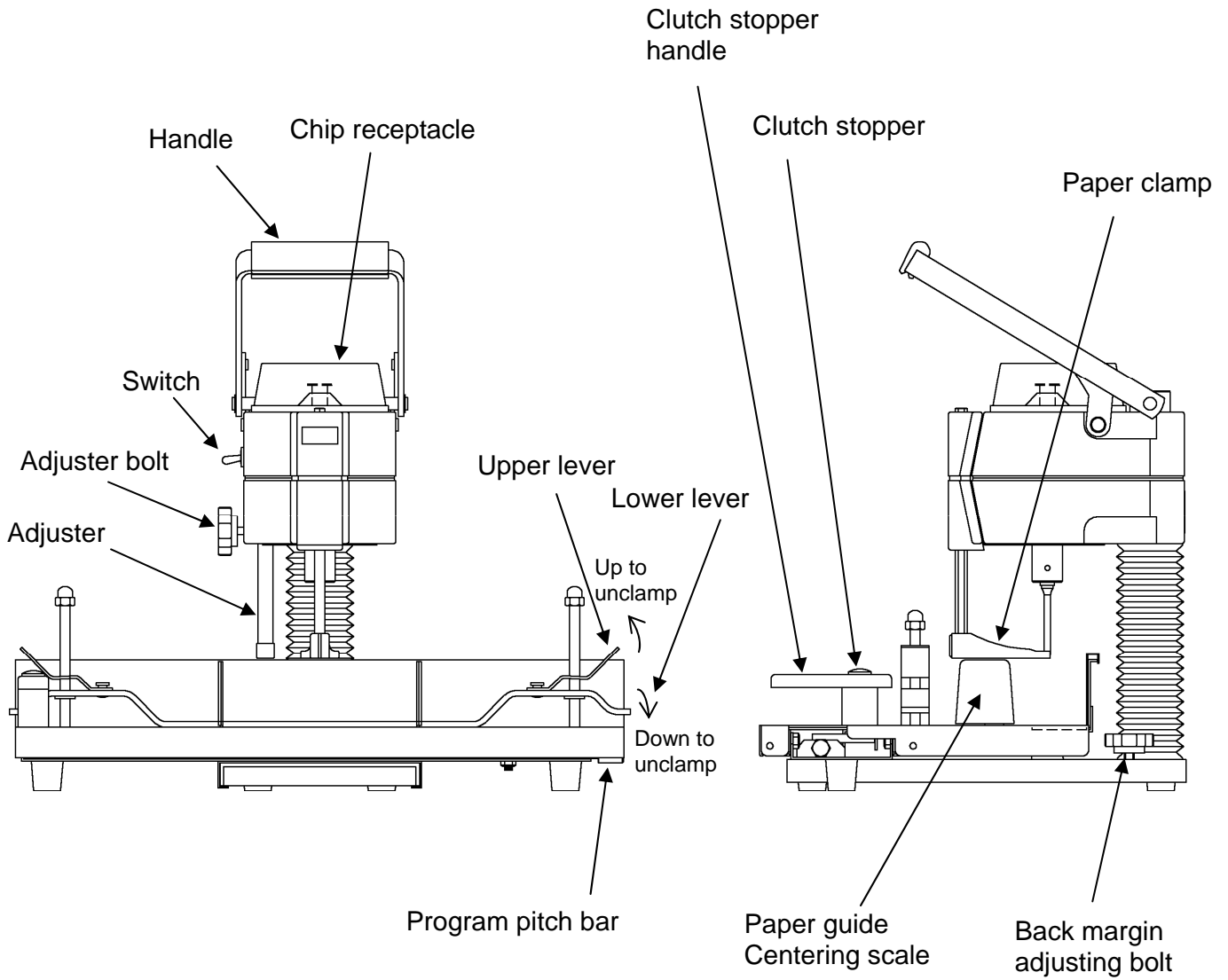





MyBinding.com  
 5500 NE Moore Court  
 Hillsboro, OR 97124  
 Toll Free: 1-800-944-4573  
 Local: 503-640-5920





## 2. Operating instructions

---

### (1) Checks before setting

 <b>Caution</b>	
	Please do not install a machine in the unstable place to which it is shaky or leans. There is a danger of receiving an injury.
	When you move, have a base. There is a danger of receiving an injury.
	When you install a machine, please install to a place with no dust, and the place which is not influenced with a liquid. It becomes the cause of failure if the installation method is mistaken.

### (2) Operating procedure

 <b>Caution</b>	
	Don't put a hand under the hollow drill bit. There is a danger of receiving an injury.
	Turn off the power supply beforehand when attaching or detaching hollow drill bits. There is a danger of receiving an injury.
	Don't touch the blade point of the hollow drill bit. There is a danger of receiving an injury.

#### (1) Setting a drill bit

Insert a drill bit into the chuck and tighten with the provided wrench.

#### (2) Setting the punch depth

After installing a drill bit, adjust the stop nut that limits downward travel so that the drill bit just enters the brown fiber plug on the table when the drill bit is fully extended.

#### (3) Setting paper

Open the paper guide and place the paper on the table.

Close the paper guide the paper will be centered on the table automatically.

Push down both sides of the paper clamp to secure the paper.

Clamping pressure should be set according to the type of the paper.

VS-15: Do not try to punch more than 30mm of paper.

VS-25: Do not try to punch more than 50mm of paper.

MyBinding.com  
 5500 NE Moore Court  
 Hillsboro, OR 97124  
 Toll Free: 1-800-944-4573  
 Local: 503-640-5920

(4) Setting the back margin









(Distance between the edge of the paper and the center of the holes)

The back margin can be set at any value from 6mm to 35mm by turning the back margin adjusting bolt (use the scale on the table as a guide).

(5) Distance of the holes

The program pitch bar can be set to select any of six pitches.

Continuous punching can be done precisely thanks to proper paper setting by the clutch stopper.

 <b>Caution</b>	
	Don't put a hand under the hollow drill bit. There is a danger of receiving an injury.
	Don't touch any rotating part. There is a danger of receiving an injury.
	Don't bring a hand, face, hair, sleeves of clothes and the like close to the rotating parts of the machine. There is a danger of receiving an injury.
	When you change into unusual states, like smoke comes out, please turn off the power switch of a main part, and pull out a power supply plug from a wall socket after that. There are failure, a fire, and fear of an electric shock.
	The hollow drill bits become heated when they are drilling. Don't touch them when they are drilling. Touching them may cause a burn.
	Don't touch the blade point of the hollow drill bit. There is a danger of receiving an injury.
	Please do not make a hole in paper with foreign substances, such as a needle of a stapling machine. Moreover, also things other than paper. There is a danger of receiving an injury.
	Please do not make a hole hard paper and near the hole which have opened in piles. There is a danger of receiving an injury.

(6) Operating the punch

Turn on the power then lower the drill bit quickly without stopping until the stop nut halts the descent (this should take about one second)

(7) Finishing the punch

After the punch finished, turn off the power. Take paper after the rotation of a drill bit completely stopped.

### 3. Maintenance





---

(1) Checking the edge of the drill bit

If punching requires more force than normally or if the drill bit lifts paper with it, it's time to sharpen the drill bit. It's a good idea to sharpen the drill bit regularly, before this happens.

(2) Sharpening the drill bit

A dull drill bit may make punching hard. A dull drill bit is more easily damaged than a sharp one. To sharpen it, follow these steps:

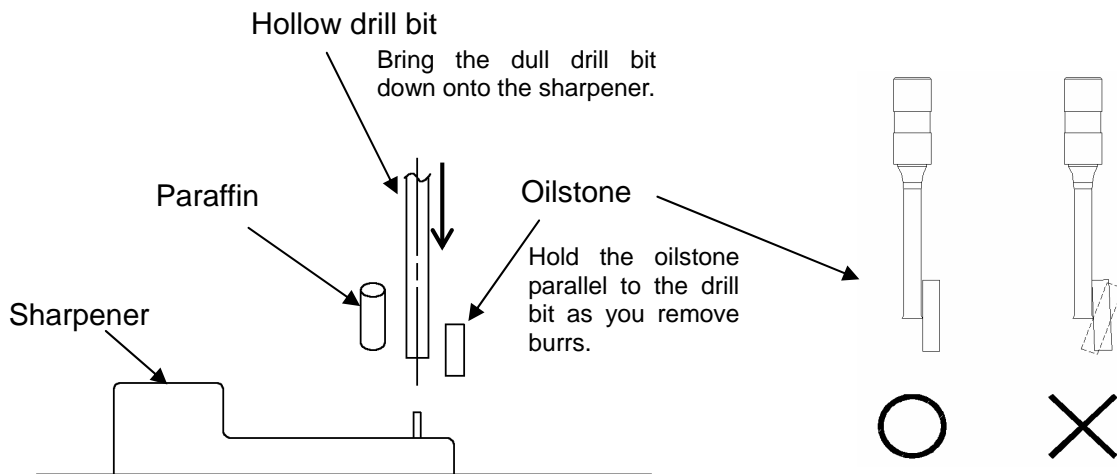

 <b>Caution</b>	
	Don't put a hand under the hollow drill bit. There is a danger of receiving an injury.
	Don't touch any rotating part. There is a danger of receiving an injury.
	Don't bring a hand, face, hair, sleeves of clothes and the like close to the rotating parts of the machine. There is a danger of receiving an injury.
	Don't touch the blade point of the hollow drill bit. There is a danger of receiving an injury.

1. Place the provided sharpener on the fiber plug as shown at the right, and turn on the power.
2. Turn the handle until the rotating drill bit touches the sharpener, then turn a little more. The drill bit is sufficiently sharp when you hear a high-pitched squeal.
3. Remove the burrs on the edge, by holding the provided oilstone parallel to the rotating drill bit and bringing then in to contact until all burrs are gone.
4. Use the paraffin to the drill bit for lubrication.



**(3) If bottom sheets are not completely punched**

The fiber plug wears out with continued use. When the bottom sheets are not punched completely, turn the fiber plug over or turn it 180 ° ; replace as necessary.



 <b>Caution</b>	
	Turn off the power supply beforehand when adjusting the fiber plug. There is a danger of receiving an injury.

**(4) Emptying the chip receptacle**

The tiny paper disks (chips) that are punched out of the paper travel up through the hollow drill bit and accumulate in the chip receptacle. Empty the receptacle often, before it becomes full. To remove the receptacle, simply lift it out of the machine. After emptying, make sure you seat it securely again.



(5) When thermal protector works

 <b>Caution</b>	
	When a machine stopped during use, turn off the power switch, and pull out a power supply plug from a wall socket after that. There is a danger of begins to turn again. And there is a danger of receiving an injury.

When machine use long hours, motor becomes hot. To avoid the damaging of the motor, rotation of drill automatically stops by activating of thermal protector. When machine become cold, drill automatically rotates again if machine switch is not turned off. This might be cause of the injure of operator. So, when thermal protector works, turn off the power switch and pull out the power supply from the outlet.

#### 4. Product specifications

	VS-15	VS-25				
Punch depth	30mm	50mm				
Diameter of drill bit	4/5/6mm	4/5/5.5/6/6.5mm (4mm: Optional adapter is required)				
Back margin	6 to 35mm	6 to 35mm (normal) 12.5 to 35 (4mm drill bit)				
Maximum paper length	376mm Automatic centering	376mm Automatic centering				
Table size	W480 x D260 mm	W480 x D260 mm				
Dimensions	W480 x D340 x H430 mm	W480 x D340 x H470 mm				
Net weight	13kg	14kg				
Power	120V	230V	240V	120V	230V	240V
	AC 50/60Hz 90W			AC 50/60Hz 180W		
Power cord length	2m (Vinyl-covered)			2m (Vinyl-covered)		

#### 5 Ordering consumables, etc.

When ordering consumables or parts such as fiber plug, specify the machine model.

Keep this "Operation Manual" at an appointed place with care so that it may be available whenever required.

If this "Operation Manual" is stained or lost, make contact with the distributor or our salesman or customer service section to ask for a new operation manual after making sure of its contents.

When transmitting this product to another person, be sure to attach this "Operation Manual" to the product.

MyBinding.com  
5500 NE Moore Court  
Hillsboro, OR 97124  
Toll Free: 1-800-944-4573  
Local: 503-640-5920